

# ARCADE PLANS

DIMMENSION GUIDE (Millimeters)

# Cut Diagram

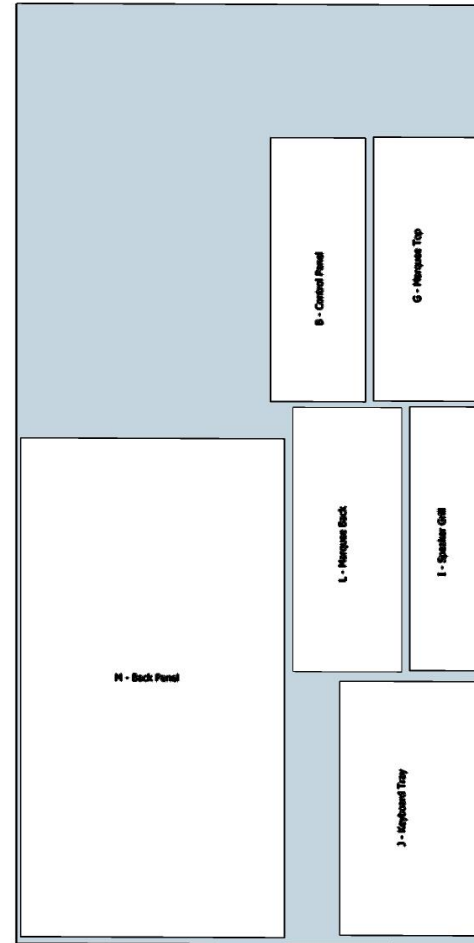
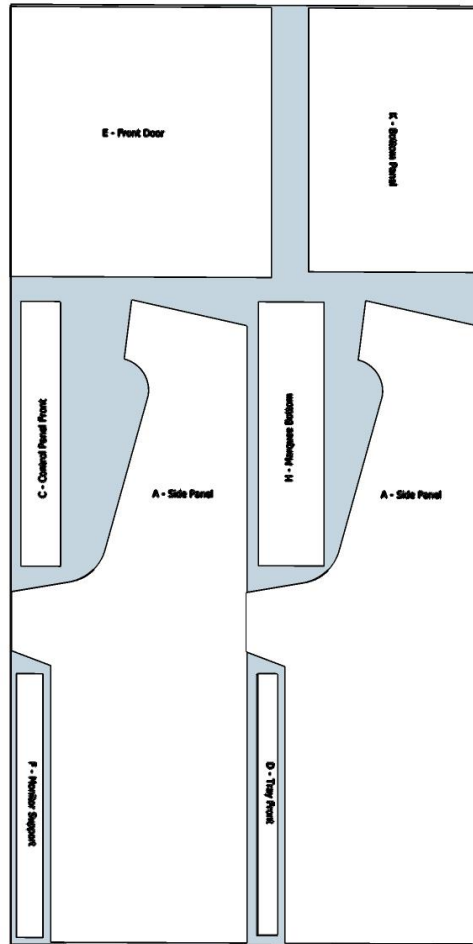

# Cut Parts A, B, C, and D

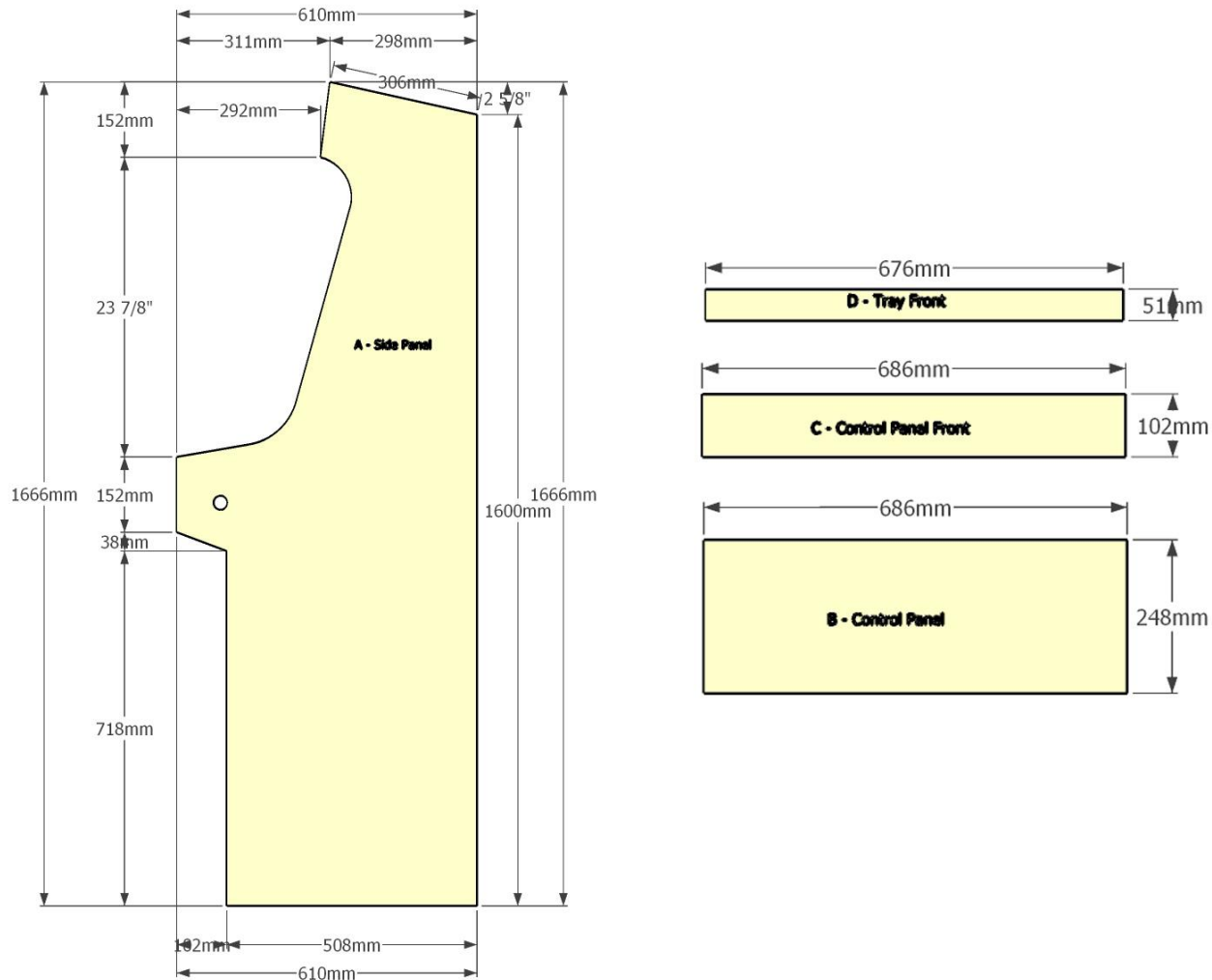

# Cut Parts E, F, G, H, and I

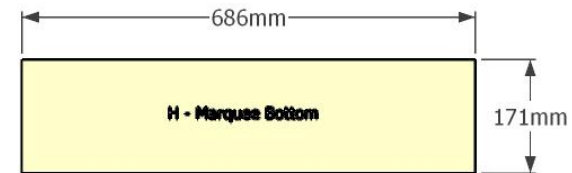
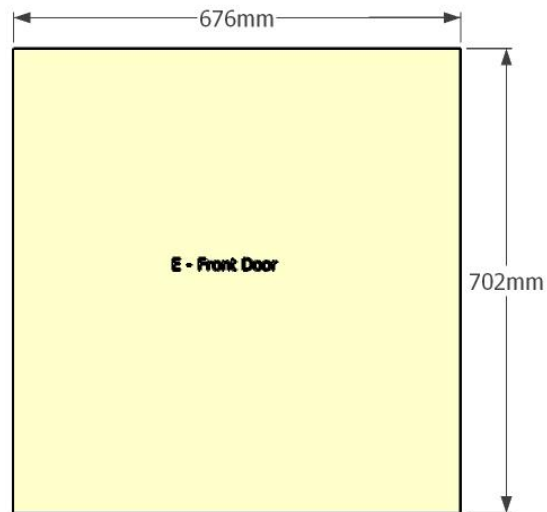

# Cut Parts J, K, and L

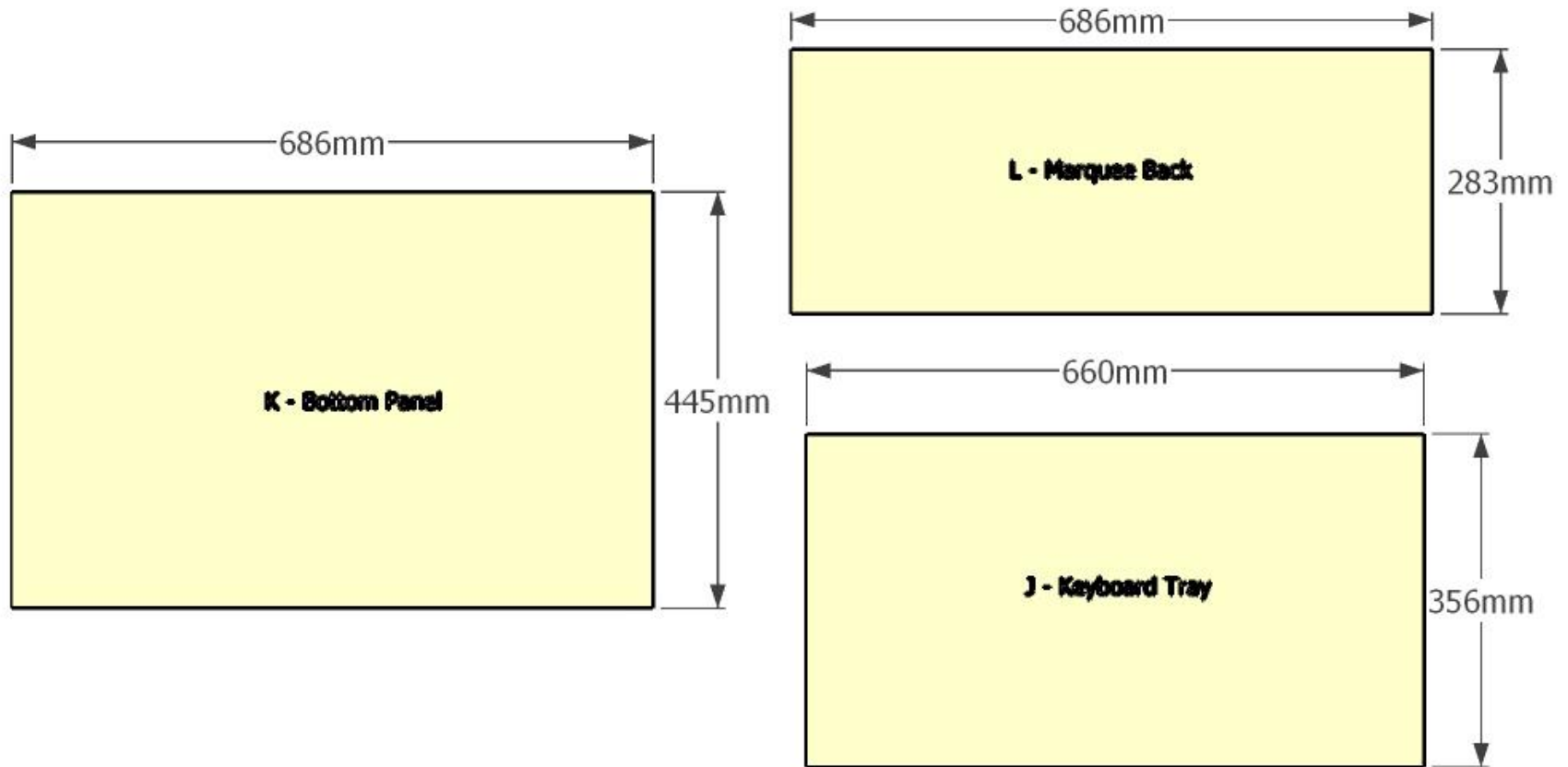

# Cut Part M

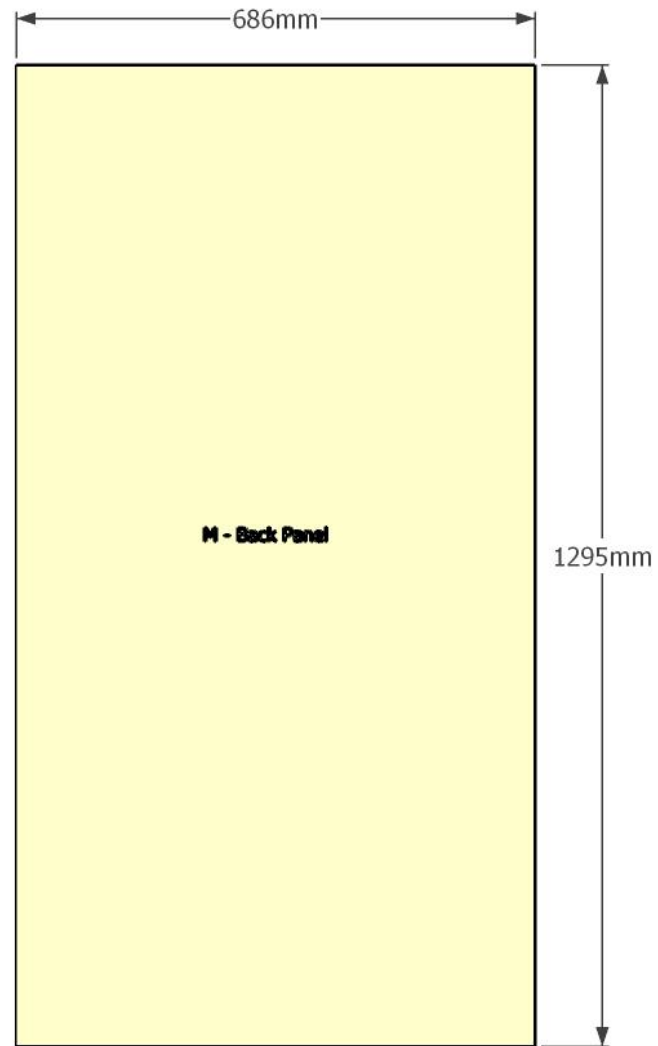

# Assembly Breakout

