

ARCADE PLANS

DIMMENSION GUIDE (INCHES)

Cut Diagram

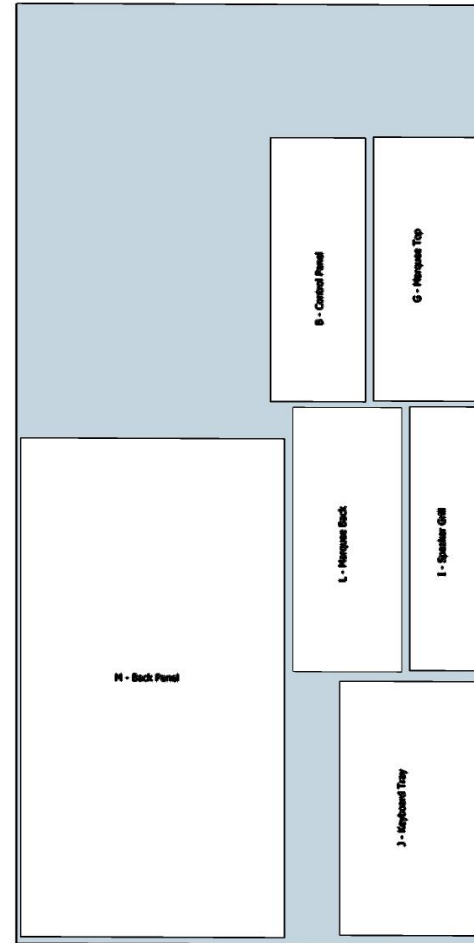
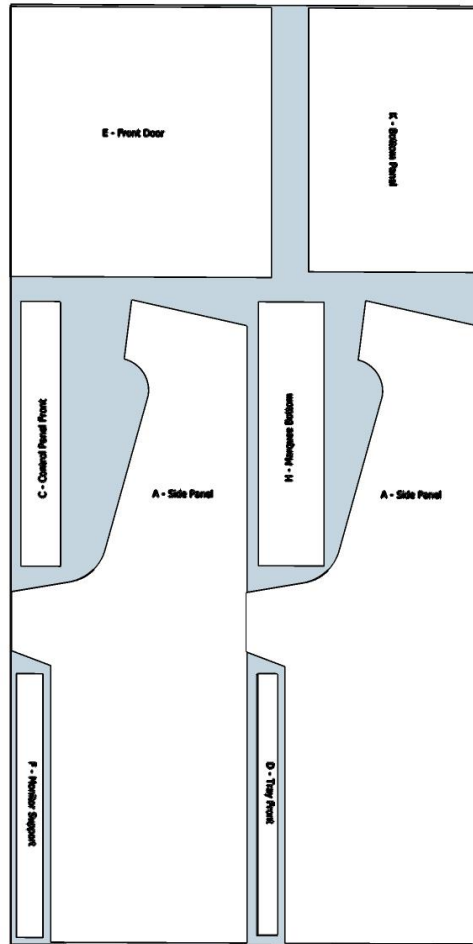

Cut Parts A, B, C, and D

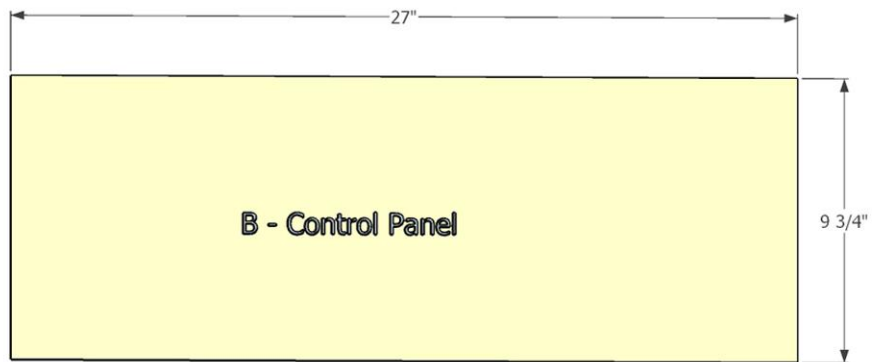
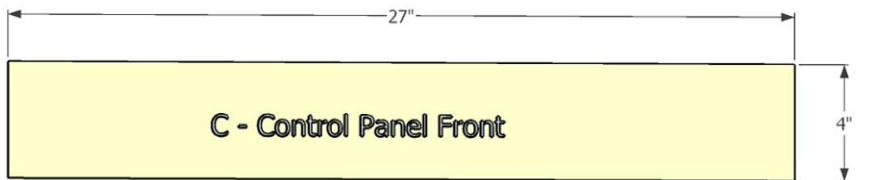
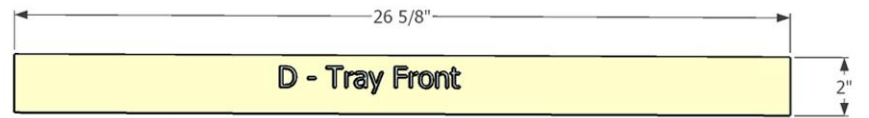
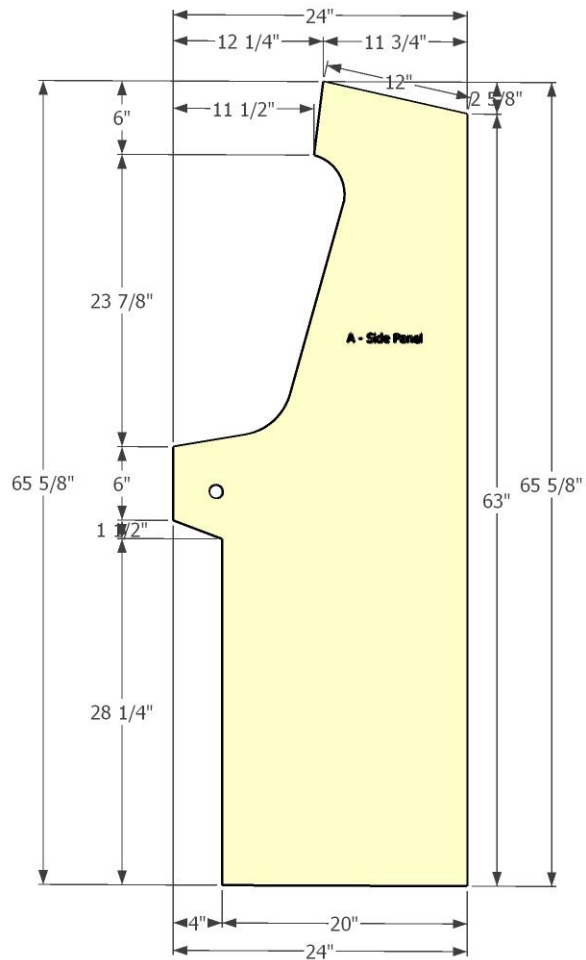

Cut Parts E, F, G, H, and I

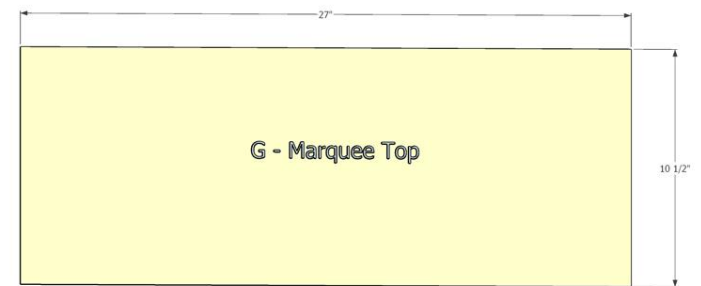
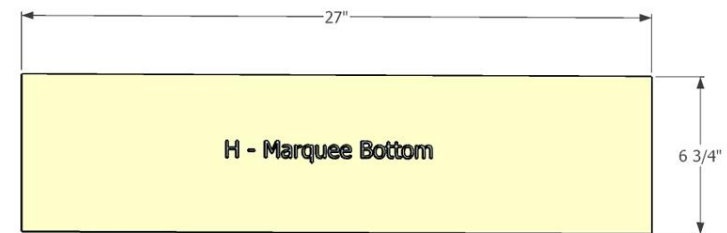
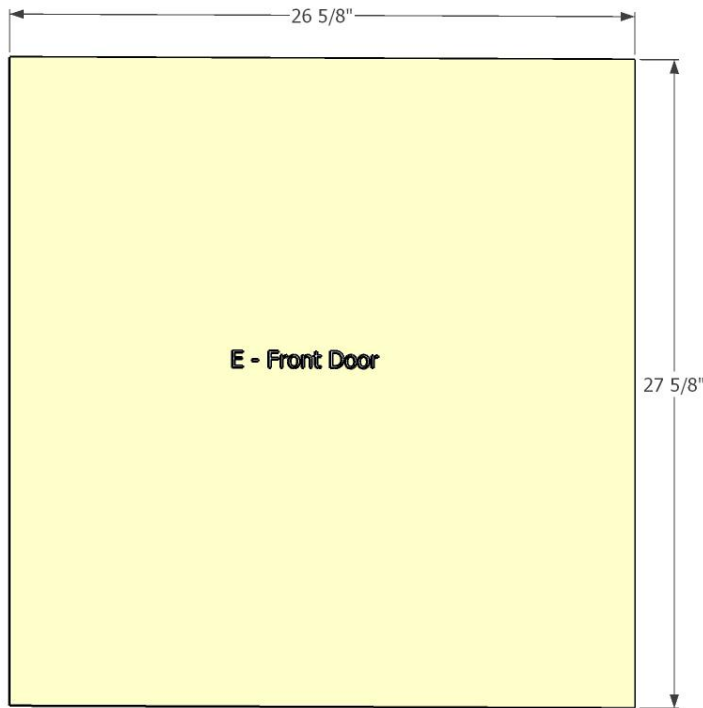
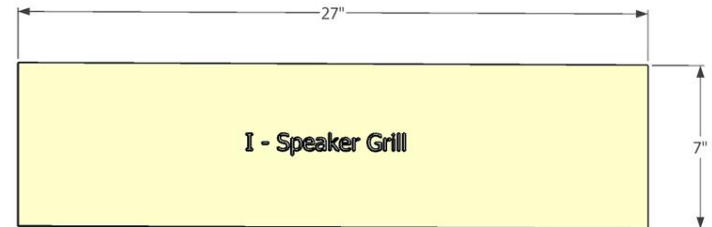
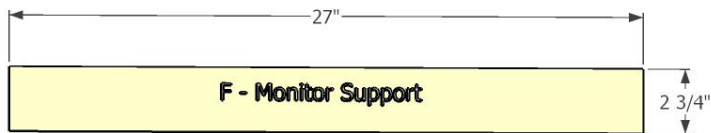

Cut Parts J, K, and L

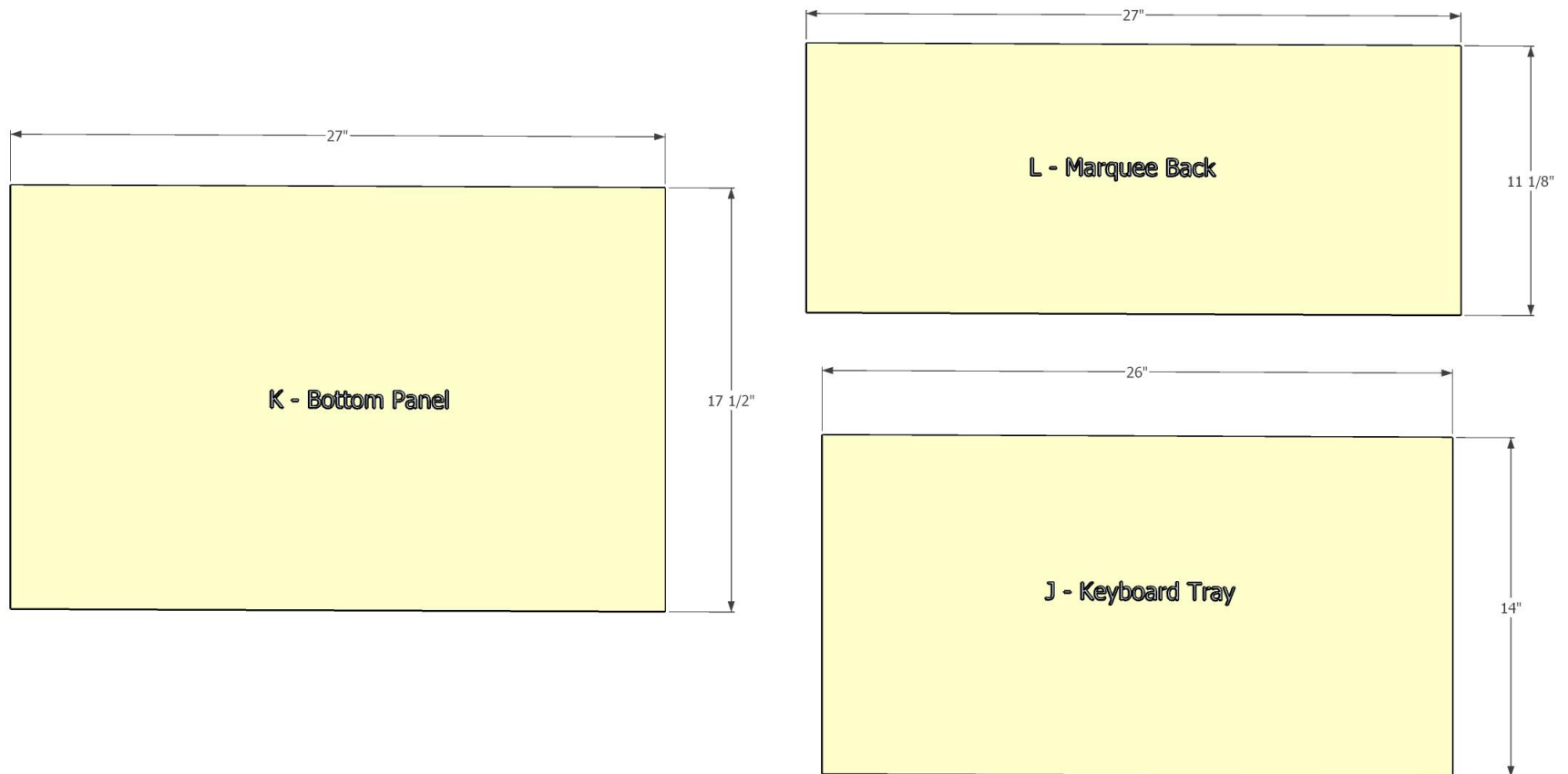

Cut Part M

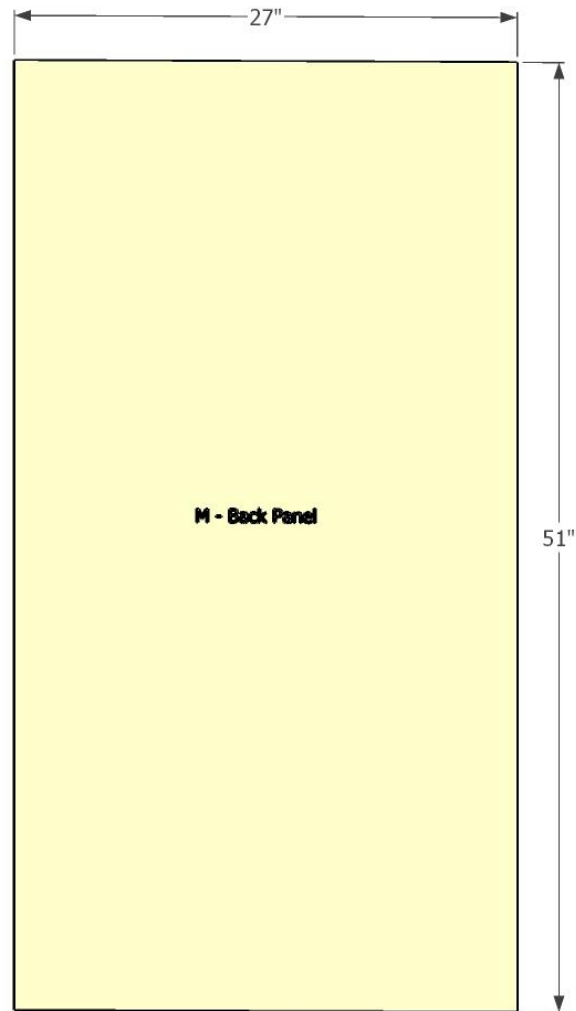

Assembly Breakout

